

## Inductive sensor NCN3-F31-B3-V1-K

- Direct mounting on standard actuators
- Mode of operation, programmable
- Lead breakage and short-circuit monitoring of the valve
- Degree of protection IP67
- Communication monitoring, turn-off

Valve positioner and valve control module



### Dimensions

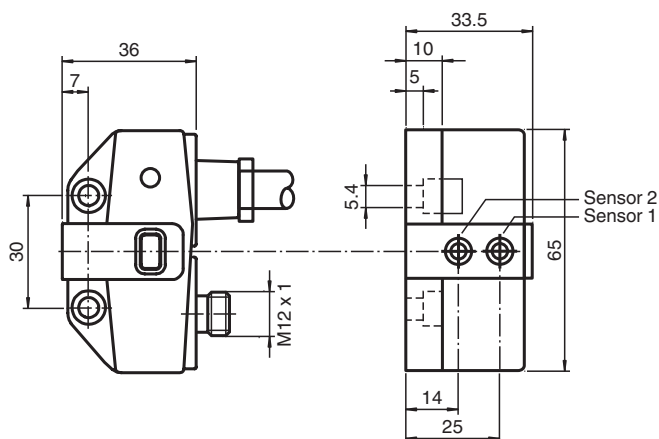

Drawing without actuator

### Technical Data

General specifications		
Switching function		Normally open/closed (NO/NC) programmable
Output type		AS-Interface
Rated operating distance	$s_n$	3 mm
Installation		flush mountable
Assured operating distance	$s_a$	0 ... 2.43 mm
Reduction factor $r_{AI}$		0.5
Reduction factor $r_{Cu}$		0.45
Reduction factor $r_{304}$		1
Reduction factor $r_{St37}$		1.2
Node type		Standard node
AS-Interface specification		V2.1
Required gateway specification		$\geq$ V2.1
Nominal ratings		
Operating voltage	$U_B$	26.5 ... 31.9 V via AS-i bus system
Switching frequency	$f$	0 ... 100 Hz
No-load supply current	$I_0$	$\leq$ 35 mA

Release date: 2022-05-23 Date of issue: 2022-05-23 Filename: 226323\_eng.pdf

Refer to "General Notes Relating to Pepperl+Fuchs Product Information".

Pepperl+Fuchs Group  
www.pepperl-fuchs.com

USA: +1 330 486 0001  
fa-info@us.pepperl-fuchs.com

Germany: +49 621 776 1111  
fa-info@de.pepperl-fuchs.com

Singapore: +65 6779 9091  
fa-info@sg.pepperl-fuchs.com

PEPPERL+FUCHS

## Technical Data

Functional safety related parameters		
MTTF <sub>d</sub>		842 a
Mission Time (T <sub>M</sub> )		20 a
Diagnostic Coverage (DC)		0 %
Indicators/operating means		
LED PWR		AS-Interface voltage; LED green
LED IN		switching state (input); LED yellow
LED OUT		binary LED yellow/red yellow: switching state red: lead breakage/short-circuit
Electrical specifications		
Rated operating voltage	U <sub>e</sub>	26.5 ... 31.6 V from AS-Interface
Rated operating current	I <sub>e</sub>	100 mA
Compliance with standards and directives		
Standard conformity		
Electromagnetic compatibility		EN 50295:1999-10
Standards		EN 60947-5-2:2007 EN 60947-5-2/A1:2012 IEC 60947-5-2:2007 IEC 60947-5-2 AMD 1:2012
Approvals and certificates		
UL approval		cULus Listed, General Purpose
CSA approval		cCSAus Listed, General Purpose
CCC approval		CCC approval / marking not required for products rated ≤36 V
Ambient conditions		
Ambient temperature		-25 ... 70 °C (-13 ... 158 °F)
Mechanical specifications		
Connection (system side)		4-pin, M12 x 1 connector
Connection (valve side)		0.5 m, PVC cable
Core cross section (valve side)		0.75 mm <sup>2</sup>
Connector housing		metal
Housing material		PBT
Degree of protection		IP67
Cable		
Cable diameter		6 mm ± 0.2 mm
Bending radius		> 10 x cable diameter
Tightening torque, fastening screws		4 Nm ... 5 Nm
Note		valve voltage limited to 26,4 V max.; valve power 2,5 W max.

Release date: 2022-05-23 Date of issue: 2022-05-23 Filename: 226323\_eng.pdf

Refer to "General Notes Relating to Pepperl+Fuchs Product Information".

Pepperl+Fuchs Group  
www.pepperl-fuchs.com

USA: +1 330 486 0001  
fa-info@us.pepperl-fuchs.com

Germany: +49 621 776 1111  
fa-info@de.pepperl-fuchs.com

Singapore: +65 6779 9091  
fa-info@sg.pepperl-fuchs.com

 PEPPERL+FUCHS

**Connection**

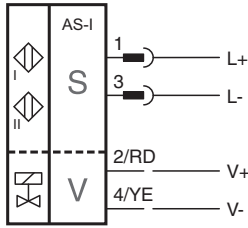

**Connection Assignment**

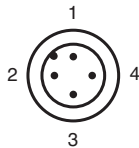

**Assembly**

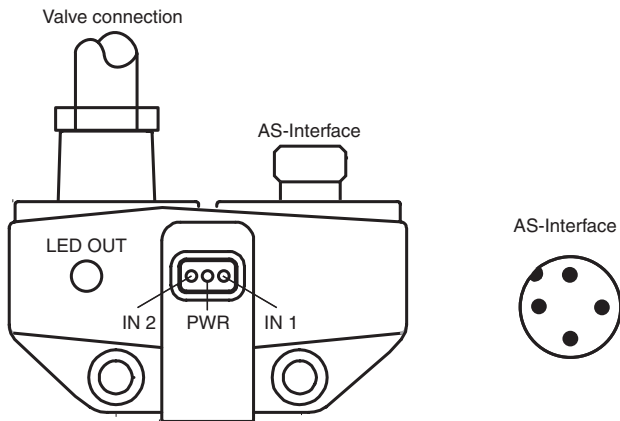

Release date: 2022-05-23 Date of issue: 2022-05-23 Filename: 226323\_eng.pdf

## Additional Information

### Programming Instructions

Address 00 preset, alterable  
 via Busmaster or programming units  
 IO-code D  
 ID-code F

#### Data bit

Bit	function
D0	valve status (0=valve OFF; 1=valve ON)
D1	valve fault <sup>1)</sup> (0=lead breakage/short circuit; 1=no fault)
D2	switch output sensor 1 <sup>2)</sup> (0=damped; 1=undamped)
D3	switch output sensor 2 <sup>2)</sup> (0=damped; 1=undamped)

#### Parameter bit

Bit	function
P0	Watchdog (0=inactive; 1=active) <sup>3)</sup>
P1	not used
P2	switching element function sensor I (0=NO; 1=NC)
P3	switching element function sensor II <sup>4)</sup> (0=NO; 1=NC)

- 1) Verification only with actuated valve (D0=1)
- 2) Applies to NC function (P2/P3=1; preset), with NO function (P2/P3=0) reversed characteristics
- 3) Watchdog active: valve voltage drops with the occurrence of an AS-i communication fault
- 4) Default setting: NC

## Connection

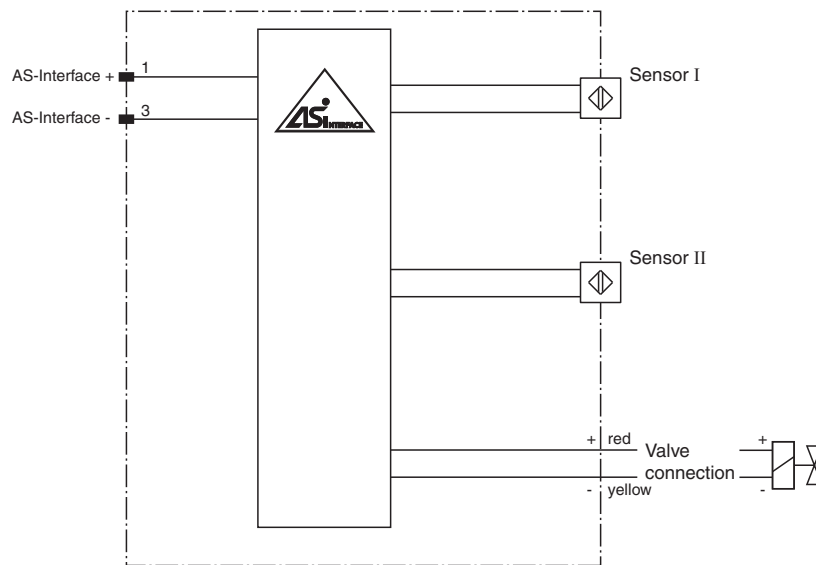





## Accessories

	<b>BT65A</b>	Activator for F31 series
---	--------------	--------------------------

Release date: 2022-05-23 Date of issue: 2022-05-23 Filename: 226323\_eng.pdf

Refer to "General Notes Relating to Pepperl+Fuchs Product Information".

**Accessories**

	<b>BT65X</b>	Activator for F31 series
	<b>BT115A</b>	Activator for F31 series
	<b>BT115X</b>	Activator for F31 series
	<b>V1-W-2M-PUR</b>	Female cordset single-ended M12 angled A-coded, 4-pin, PUR cable grey
	<b>V1-G-2M-PUR</b>	Female cordset single-ended M12 straight A-coded, 4-pin, PUR cable grey

Release date: 2022-05-23 Date of issue: 2022-05-23 Filename: 226323\_eng.pdf

Refer to "General Notes Relating to Pepperl+Fuchs Product Information".

Pepperl+Fuchs Group  
www.pepperl-fuchs.com

USA: +1 330 486 0001  
fa-info@us.pepperl-fuchs.com

Germany: +49 621 776 1111  
fa-info@de.pepperl-fuchs.com

Singapore: +65 6779 9091  
fa-info@sg.pepperl-fuchs.com

## Function

The NCN3-F31-B3-V1-K is an inductive dual sensor used to indicate the valve positioning of actuators. The dual sensor is mounted directly on the actuator using two screws. No additional adjustment is required.

A cable connection on the sensor is used directly for the valve controls. The NCN3-F31-B3-V1-K is connected via a M12x1 screw fixing to the bus line. This makes it possible to transmit both the switch signal for the valve and the messages of the sensor via AS-Interface. They are both powered directly through the bus cable. Moreover, the valve is monitored for lead breakage and short circuit. The D1 data bit monitors the fault signal.

The sensors can be programmed as normally closed and normally open contacts (parameter bit P2 and P3). If there are no communications on the bus cable, the valve is automatically de-energised. The P0 parameter bit disables the watchdog function. The current switching states are displayed by means of yellow LEDs.